

Data sheet

Dimensions

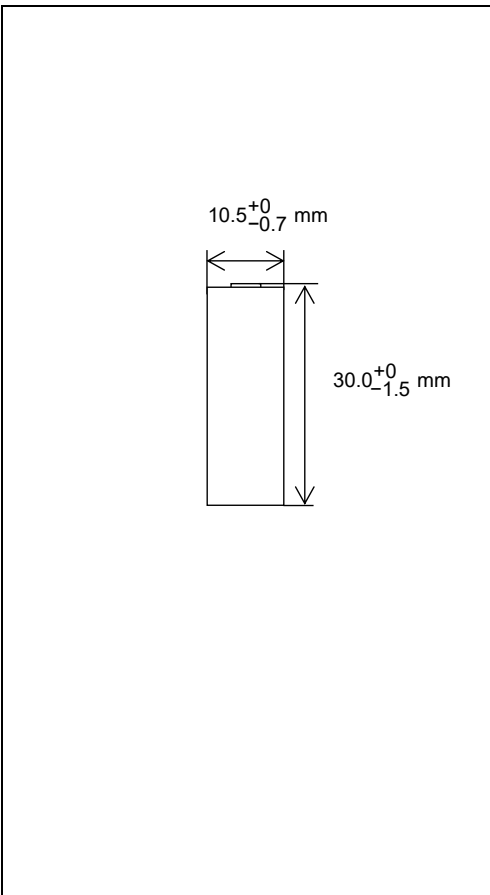

Dimensions (including tube)	Diameter	10.5 +0/ -0.7 mm
	Height	30.0 +0/ -1.5 mm
Approx. Weight (including tube)		8 g
Approx. Internal Impedance at 1kHz 20 °C ₆₎		30 mΩ

6) After 3 cycles of charge and discharge under the conditions of 1), followed by the measurement 1~4 hours later.

Capacity

Nominal ₁₎	220 mAh
Minimum ₁₎	200 mAh

1)Single cell capacity under the following condition.
Charge : 20 mA x 16 hours, Discharge : 40 mA(E.V.=1.00 V) at 20 °C

General Specifications

Nominal Voltage		1.2 V	
End Voltage		1.00 V	
Charging Current x Time	Normal Charge	20 mA x 16 hours	
	Fast Charge ₂₎	220 mA x about 1.1 hours	
Ambient Temp.	Charge Condition ₃₎	Normal Charge	0 °C ~ +50 °C
		Fast Charge ₂₎	0 °C ~ +40 °C
	Discharge Condition ₃₎	Recommended	0 °C ~ +50 °C
		Possible ₄₎	-30 °C ~ +85 °C
Relative Humidity ₅₎		45 % ~ 85 %	

- 2)Use recommended charging system.
- 3)Charge or discharge on outside the recommended temperature range may generate the battery degradation.
- 4)Only low rate discharge at low temperature.
- 5)No water condensation.

Storage Conditions

Ambient Temp.	Less than 30 days	-40 °C ~ +50 °C
	Less than 90 days	-40 °C ~ +40 °C
	Less than 1 year	-40 °C ~ +30 °C
Relative Humidity ₇₎		45 % ~ 85 %

7)No water condensation.

Nominal Charge Characteristics

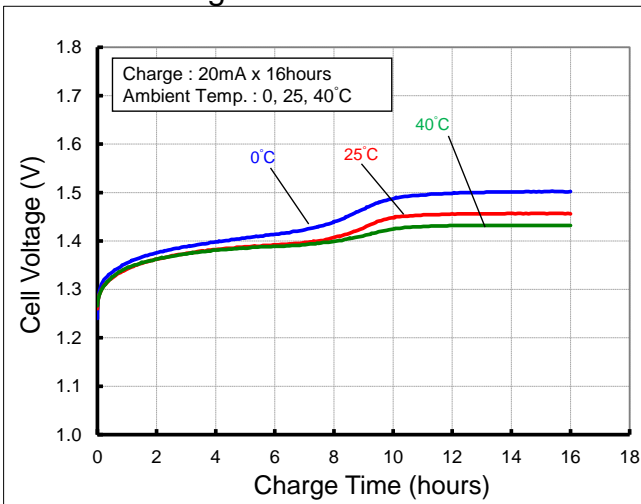

Nominal Discharge Characteristics

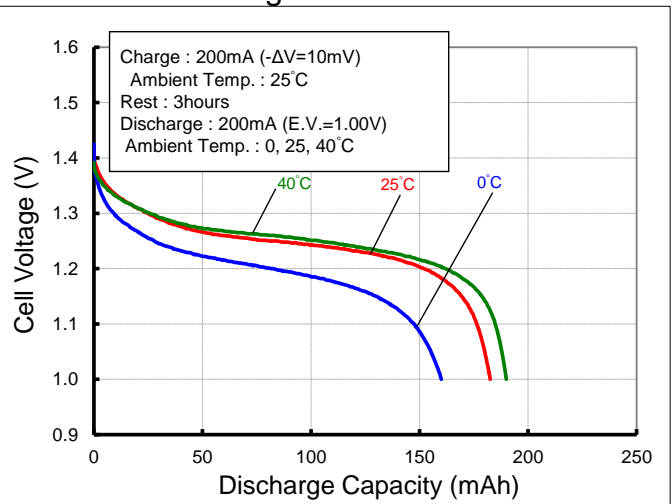

- Single cell performance and lifespan are greatly affected by usage and temperature conditions.
- Test results vary depending on individual cells.
- Each values included in this material are intended to describe performance. They are not guaranteed.