

### Data sheet

#### Dimensions

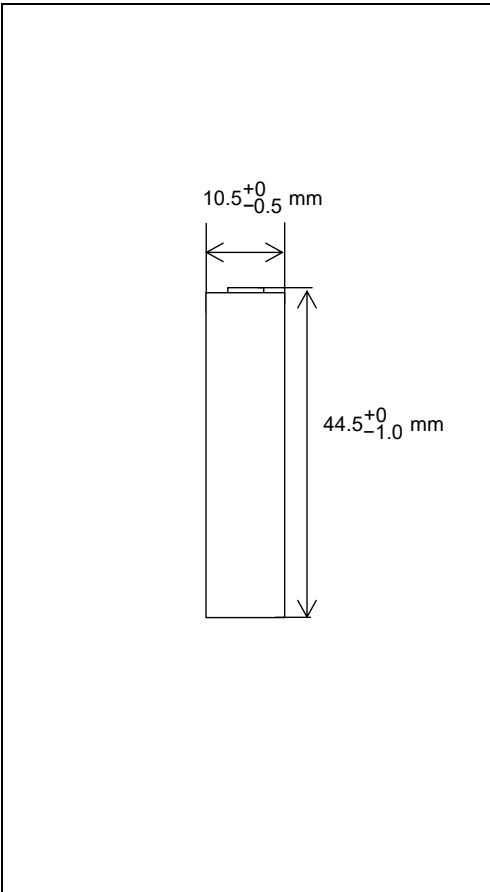

Dimensions (including tube)	Diameter	10.5 +0/ -0.5 mm
	Height	44.5 +0/ -1.0 mm
Approx. Weight (including tube)		13 g
Approx. Internal Impedance at 1kHz 20°C <sub>6)</sub>		30 mΩ

6) After 3 cycles of charge and discharge under the conditions of 1), followed by the measurement 1~4 hours later.

#### Capacity

Nominal <sub>1)</sub>	500 mAh
Minimum <sub>1)</sub>	460 mAh

1)Single cell capacity under the following condition.

Charge : 46 mA x 16 hours, Discharge : 92 mA(E.V.=1.00 V) at 20 °C

#### General Specifications

Nominal Voltage		1.2 V	
End Voltage		1.00 V	
Charging Current x Time	Normal Charge	46 mA x 16 hours	
	Fast Charge <sub>2)</sub>	500 mA x about 1.1 hours	
Ambient Temp.	Charge Condition <sub>3)</sub>	Normal Charge	0 °C ~ +50 °C
		Fast Charge <sub>2)</sub>	0 °C ~ +40 °C
	Discharge Condition <sub>3)</sub>	Recommended	0 °C ~ +50 °C
		Possible <sub>4)</sub>	-30 °C ~ +85 °C
Relative Humidity <sub>5)</sub>		45 % ~ 85 %	

2)Use recommended charging system.

3)Charge or discharge on outside the recommended temperature range may generate the battery degradation.

4)Only low rate discharge at low temperature.

5)No water condensation.

#### Storage Conditions

Ambient Temp.	Less than 30 days	-40 °C ~ +50 °C
	Less than 90 days	-40 °C ~ +40 °C
	Less than 1 year	-40 °C ~ +30 °C
Relative Humidity <sub>7)</sub>		45 % ~ 85 %

7)No water condensation.

#### Nominal Charge Characteristics

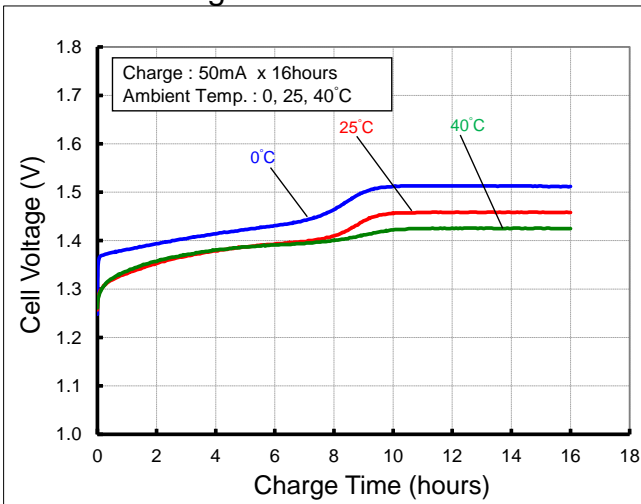

#### Nominal Discharge Characteristics

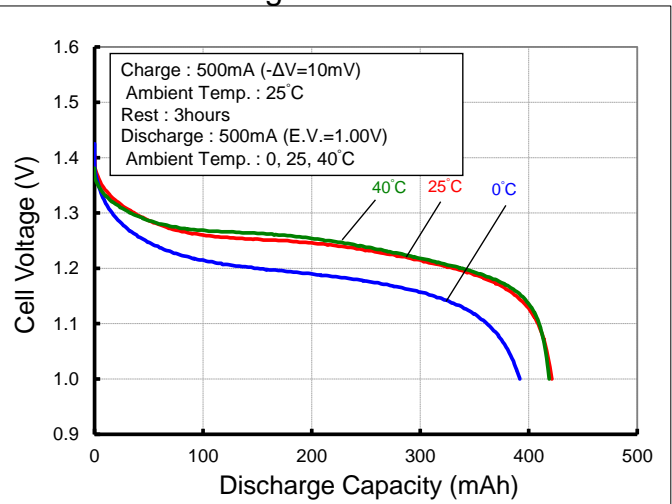

- Single cell performance and lifespan are greatly affected by usage and temperature conditions.
- Test results vary depending on individual cells.
- Each values included in this material are intended to describe performance. They are not guaranteed.